

Mid-woofer

W218-8

Features

- 218 mm 8 Ω loudspeaker
- great audio fidelity and superior price
- stamped steel frame with profile lip
- designed for front mounting or countersinking
- coated paper cone
- smooth frequency response and linear roll-off
- simplify filter design



Frequency response (0° & 30°), Impedance curve

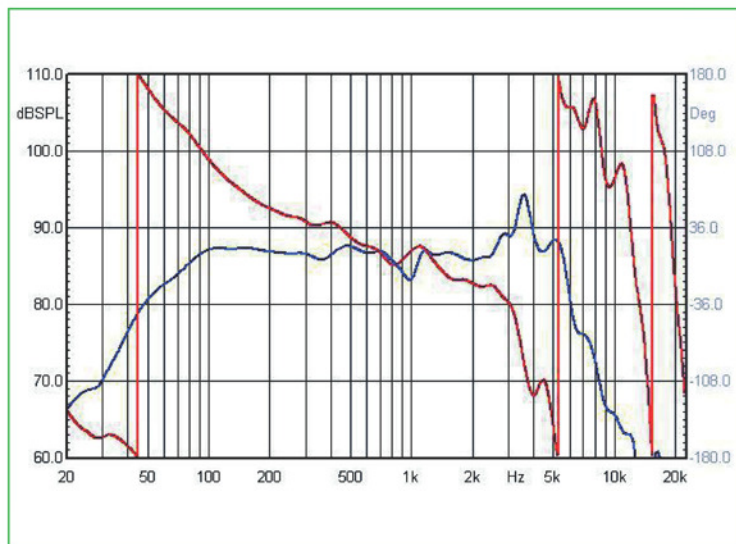

Technical specifications

Frequency range	Hz
Nominal impedance	8 Ω
Music (W)	210
Nominal (W)	90
Cone	Paper
Surround material	Rubber
Basket material	Steel
Magnet material	Ferrite
Outside diameter	–
Build in hole diameter	–
Build in depth	–
SPL (1W/1M)	87

Mechanical drawing

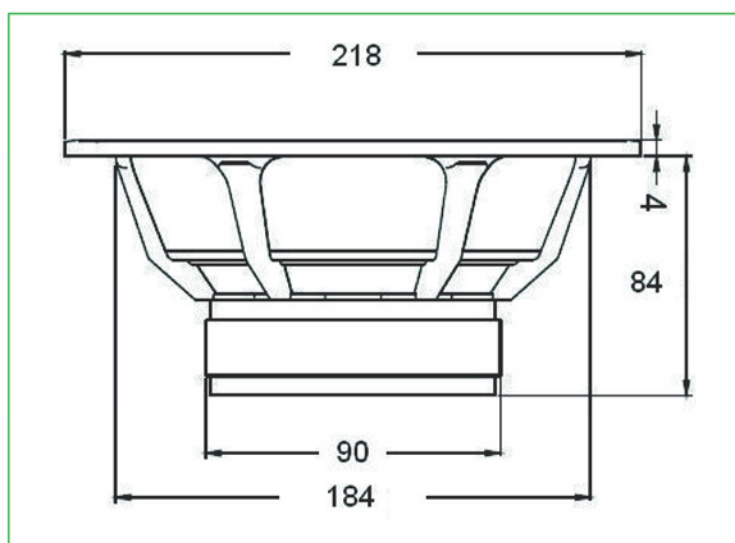

Thiele and Small parameters

	Value	Symbol
fs	38	Hz
VAS	44,9	L
QMS	3,7	–
QES	1,05	–
QTS	0,82	–
Re	6,5	Ω
LE	–	VC/mH
BL	–	(NA) (F/l)